

1000mm x 900mm RECTANGLE

SURFACE MATERIAL: Acrylic Capped ABS

REINFORCEMENT: Resin Bonded Stone

TRAY HEIGHT: 45mm

PLINTH HEIGHT (OPTIONAL): 100mm

WEIGHT: 41kg

CE CERT: BS EN 14527 - Class 1 Shower Tray

COMMODITY CODE: 39229000

AVAILABLE FINISHES:

- Gloss White
- Matt Textured White
- Matt Textured Anthracite
- Matt Textured Black
- Soft Cream
- Champagne/Ivory

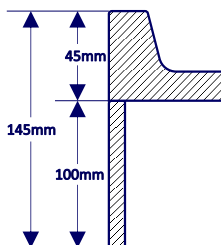
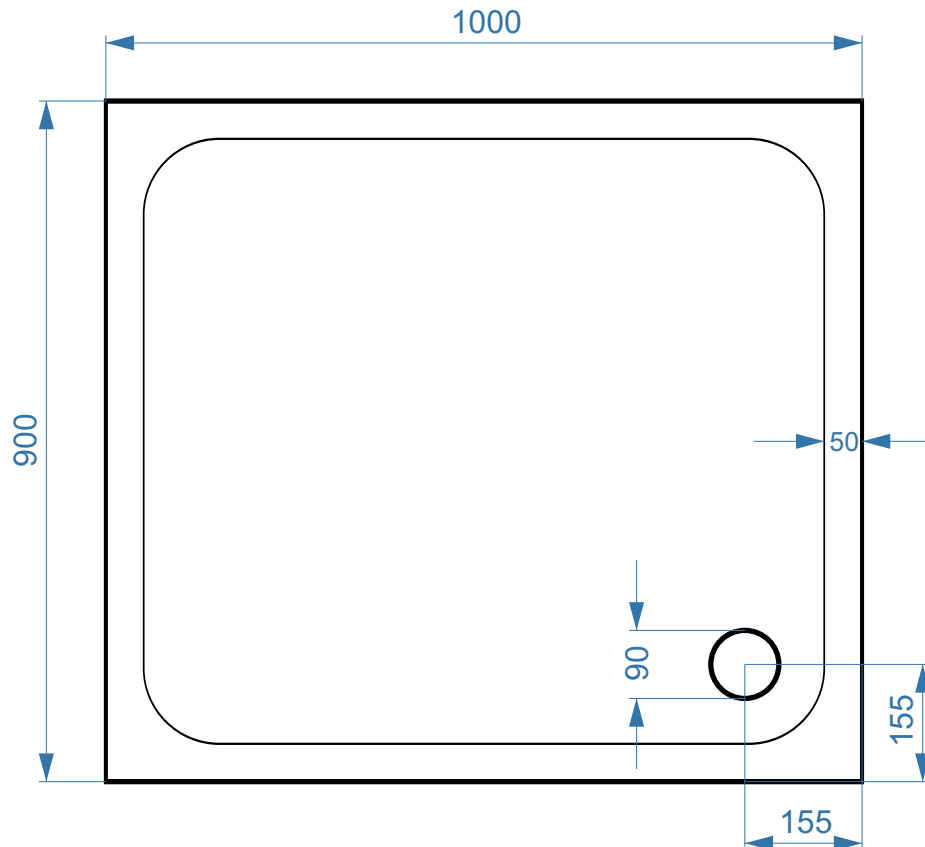

Optional Plinth Kit

SPA-JET LIMITED

17 Hawthorn Terrace, Coleraine, BT52 2BW
 Tel: +44 (0)28 7035 7103 Fax: +44 (0)28 7032 9549
 eMail: SpaJetLtd@btconnect.com web: www.SpaJet.co.uk
 Co. Reg No. NI036381 VAT Reg. No. GB 432 747 351

All measurement stated in mm to tolerance of +/-5mm

